

Clean: Separator GRASIMI GRP GEasy 2LS D800 H1530 IN/OUT Ø110 (SGGLR2LS)

SGGLR2LS

800 mm
DIAMETRU

1530 mm
ÎNĂLȚIME/LUNGIME



UTILIZARE:

Separatoarele de GRASIMI GRP se pot folosi in mai multe domenii de utilizare:

- preepurarea apelor infectate cu grasimi de origine vegetala sau animala
- ape provenite din bucatarii; fabrici; unitati producatoare din industria alimentara;
- impiedica infundarea retelelor de canalizare cu depuneri de grasime.

CONDIȚII DE CALITATE:

- Declaratie de performanta
- Conform Regulament UE 305/2011
- ISO 9001

AVANTAJE:

- Diferite volumetrii aplicatii personalizate;
- Instalare si montaj usor si rapid;
- Dimensiuni optimizate pentru transport;
- Permit dezasamblarea separatorului in segmente permitand astfel o manipulare mai usoara in timpul transportului sau in site.

DURATĂ DE VIAȚĂ:

- Garantie 2 ani
- Durata de viata 50 ani

MONTAJ

Montajul și punerea în funcțiune se face conform instrucțiunilor oferite de producător.



Pentru un montaj eficient, recomandăm folosirea etanșantului G12M29C. Este utilizat pentru sigilarea rigolelor, țevilor și sistemelor pentru drenaj.



- Durata de întărire: 24h/2-3 mm
- Temperatura de utilizare: +5° C până la +40°C
- Temperatura maximă de depozitare: 32°C

Etanșant BASE, produse pentru construcții, tub 310 ml (G12M29-C).

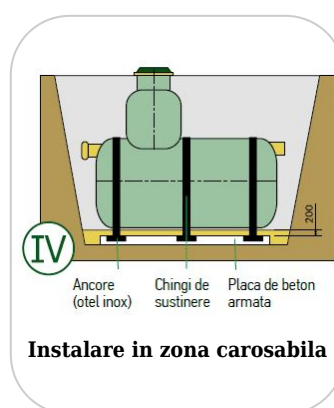
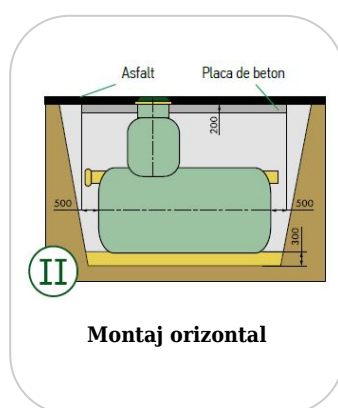
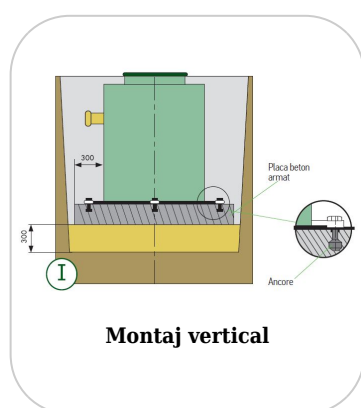

Accesorii SGGLR2LS

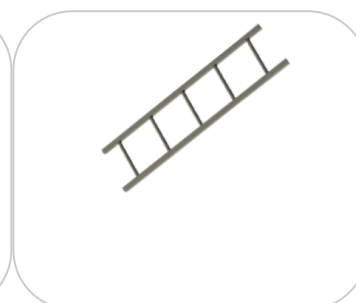
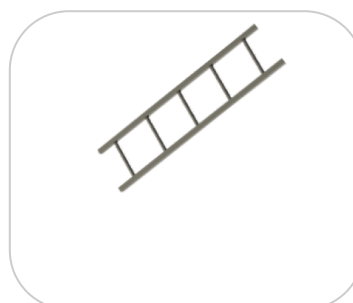
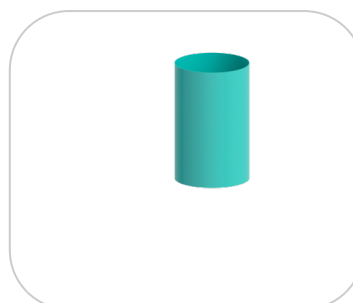
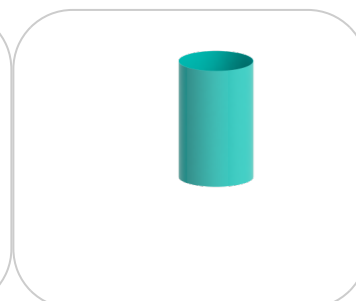
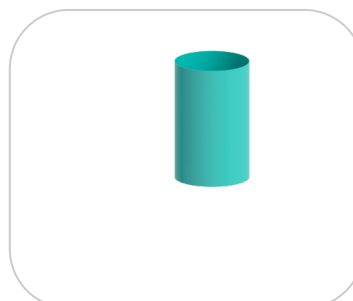

| Nr. crt. | Model / Codificare | Debit nominal (l/s) | Diametru (mm) | Înălțime separator (mm) | Înălțime racord intrare (mm) | Înălțime racord ieșire (mm) | Diametre racorduri intrare/ieșire | Volumul util calculat (litri) | Volumul Grasimi (litri) |
|----------|--------------------|---------------------|---------------|-------------------------|------------------------------|-----------------------------|-----------------------------------|-------------------------------|-------------------------|
| 1 | SGGLR0.5LS | 0,5 | 620 | 1300 | 800 | 730 | 110/110 | 220 | 37 |
| 2 | SGGLR1LS | 1 | 620 | 1230 | 900 | 830 | 110/110 | 251 | 42 |
| 3 | SGGLR1,5LS | 1,5 | 800 | 1230 | 800 | 730 | 110/110 | 367 | 61 |
| 4 | SGGLR2LS | 2 | 800 | 1530 | 1100 | 1030 | 110/110 | 518 | 86 |
| 5 | SGGLR2,5LS | 2,5 | 1000 | 1390 | 900 | 830 | 110/110 | 652 | 109 |
| 6 | SGGLR3LS | 3 | 1000 | 1490 | 1000 | 930 | 110/110 | 730 | 122 |
| 7 | SGGLR3,5LS | 3,5 | 1200 | 1400 | 900 | 830 | 110/110 | 939 | 156 |
| 8 | SGGLR4LS | 4 | 1200 | 1500 | 1000 | 930 | 110/110 | 1052 | 175 |
| 9 | SGGLR4,5LS | 4,5 | 1200 | 1700 | 1100 | 1030 | 160/160 | 1165 | 194 |
| 10 | SGGLR5LS | 5 | 1400 | 1600 | 900 | 830 | 160/160 | 1278 | 213 |
| 11 | SGGLR5.5LS | 5,5 | 1400 | 1700 | 1000 | 930 | 160/160 | 1432 | 239 |
| 12 | SGGLR6LS | 6 | 1400 | 1800 | 1100 | 1030 | 160/160 | 1586 | 264 |
| 13 | SGGLR7LS | 7 | 1600 | 1750 | 1000 | 930 | 160/160 | 1870 | 312 |
| 14 | SGGLR8LS | 8 | 1600 | 1850 | 1100 | 1030 | 160/160 | 2071 | 345 |
| 15 | SGGLR9LS | 9 | 1800 | 1760 | 1000 | 930 | 160/160 | 2367 | 394 |
| 16 | SGGLR10LS | 10 | 1800 | 1860 | 1100 | 1030 | 160/160 | 2621 | 437 |
| 17 | SGGLR12LS | 12 | 2000 | 1860 | 1000 | 930 | 200/200 | 2922 | 487 |
| 18 | SGGLR13LS | 13 | 2200 | 1790 | 900 | 830 | 200/200 | 3155 | 526 |
| 19 | SGGLR14LS | 14 | 2200 | 1890 | 1000 | 930 | 200/200 | 3535 | 589 |
| 20 | SGGLR15LS | 15 | 2200 | 1990 | 1100 | 1030 | 200/200 | 3915 | 653 |
| 21 | SGGLR17LS | 17 | 2400 | 1890 | 1000 | 930 | 200/200 | 4207 | 701 |
| 22 | SGGLR18LS | 18 | 2400 | 1990 | 1100 | 1030 | 200/200 | 4660 | 777 |
| 23 | SGGLR20LS | 20 | 2600 | 1900 | 1000 | 930 | 200/200 | 4938 | 823 |
| 24 | SGGLR21LS | 21 | 2600 | 2000 | 1100 | 1030 | 200/200 | 5469 | 911 |
| 25 | SGGLR23LS | 23 | 2800 | 1900 | 1000 | 930 | 200/200 | 5726 | 954 |
| 26 | SGGLR24LS | 24 | 2800 | 2000 | 1100 | 1030 | 200/200 | 6342 | 1057 |
| 27 | SGGLR25LS | 25 | 3000 | 1960 | 1000 | 930 | 200/200 | 6574 | 1096 |
| 28 | SGGLR28LS | 28 | 3000 | 2060 | 1100 | 1030 | 200/200 | 7281 | 1213 |

CARACTERISTICI

| | |
|---|---|
| Nume produs | Separator GRASIMI GRP GEasy 2LS D800 H1530 IN/OUT Ø110 (SGGLR2LS) |
| Cod produs | SGGLR2LS |
| EAN | 6427669007470 |
| Categorie | Separatoare Grasimi GRP |
| Brand | Clean |
| Greutate | 70.00 kg |
| Disponibilitate stoc | La comanda |
| Inaltime (H), mm | 1530 |
| Diametru interior / pasul liber (mm) | 620 |
| Diametru racord intrare, (DNin) mm | 110 |
| Diametru racord iesire, (DNout) mm | 110 |
| Material Produs | Poliester armat cu fibră de sticlă (PAFS/GRP) |
| Debit nominal (Q, l/s) | 2 |
| Volum total (Vt, litri) | - |
| Volum util (Vu, litri) | 518 |
| Volum grasimi (Vg, litri) | 86 |
| Trapa de namol, (litri) | - |
| Sistem de Fixare | |
| Garantie, luni | 24 |
| Durata de viata, ani | 50 |
| Producator | |