

Rigola cu scurgere verticala

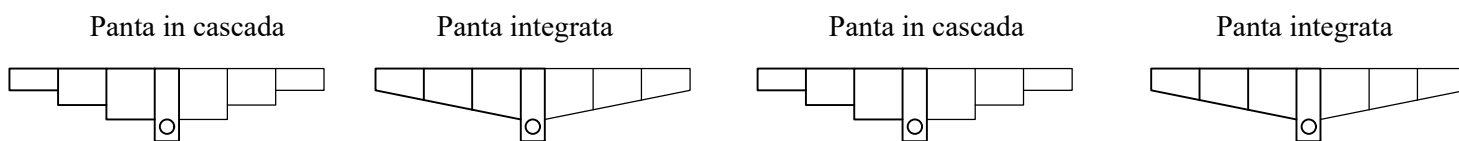

| Articol | H/h, mm | Greutate, kg | Article | H/h, mm | Weight, kg | Article | H/h, mm | Weight, kg | Article | H/h, mm | Weight, kg |
|----------|---------|--------------|--------------|---------|------------|------------|---------|------------|----------------|---------|------------|
| 4000/150 | 150 | 26,5 | 4000/150-145 | 150/145 | 26,3 | 400009/150 | 150 | 25,9 | 400009/150-145 | 150/145 | 25,7 |
| 4000/145 | 145 | 26 | 4000/145-140 | 145/140 | 25,8 | 400009/145 | 145 | 25,4 | 400009/145-140 | 145/140 | 25,2 |
| 4000/140 | 140 | 25,5 | 4000/140-135 | 140/135 | 25,3 | 400009/140 | 140 | 24,9 | 400009/140-135 | 140/135 | 24,7 |
| 4000/135 | 135 | 25 | 4000/135-130 | 135/130 | 24,8 | 400009/135 | 135 | 24,4 | 400009/135-130 | 135/130 | 24,2 |
| 4000/130 | 130 | 24,5 | 4000/130-125 | 130/125 | 24,3 | 400009/130 | 130 | 23,9 | 400009/130-125 | 130/125 | 23,7 |
| 4000/125 | 125 | 24 | 4000/125-120 | 125/120 | 23,8 | 400009/125 | 125 | 23,4 | 400009/125-120 | 125/120 | 23,2 |
| 4000/120 | 120 | 23,5 | 4000/120-115 | 120/115 | 23,3 | 400009/120 | 120 | 22,9 | 400009/120-115 | 120/115 | 22,7 |
| 4000/115 | 115 | 23 | 4000/115-110 | 115/110 | 22,8 | 400009/115 | 115 | 22,4 | 400009/115-110 | 115/110 | 22,2 |
| 4000/110 | 110 | 22,5 | 4000/110-105 | 110/105 | 22,3 | 400009/110 | 110 | 21,9 | 400009/110-105 | 110/105 | 21,7 |
| 4000/105 | 105 | 22 | | | | 400009/105 | 105 | 21,4 | | | |

1. Dimensiuni pentru referinta
2. Livrarea și ambalarea se efectuează în conformitate cu termenii contractului
3. Producătorul își rezervă dreptul, fără notificarea consumatorului, de a face modificări în designul produselor pentru îmbunătățirea parametrilor lor tehnologici și operaționali, care nu vor afecta calitatea și proprietățile produsului.
4. Abateră greutății nominale poate fi de până la 8%.

| | | | | | |
|--|--|--|--------------|-----------|---------------------------|
| IN CAZUL IN CARE NU SE PRECIZEAZA ALTFEL, TOATE DIMENSIUNILE SUNT IN MM TOLERANTE: ISO 2768 - C LINIAR: UNGHILAR: | | | FINALIZAT: | | REVIZIA |
| DESEMAT | | | NUME | SEMNETURA | DATA |
| VERIFICAT | | | Olander | | 07.10.2022 |
| APROBAT | | | Kyselytsia | | |
| MODIFICAT | | | Malynovskiy | | |
| | | | Larisa Chițu | | |
| | | | MATERIAL: | | TITLU: |
| | | | Fibrobeton | | Rigola FB LN100 H125 |
| | | | GREUTATE: | | Clasa de sarcina A15-C250 |
| | | | | | ARTICOL: |
| | | | | | 4000 |
| | | | | | A3 |
| | | | SCARA:1:5 | | PAGINA 1 DIN 1 |

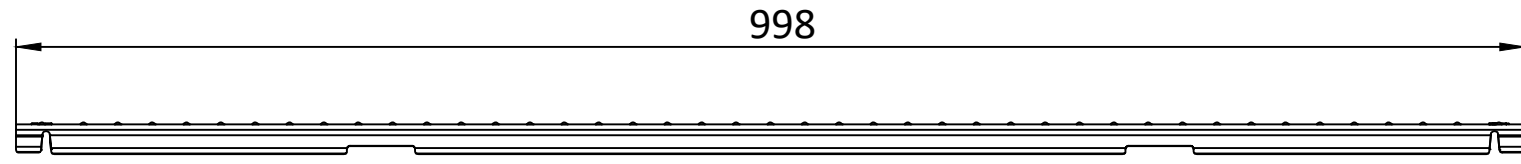
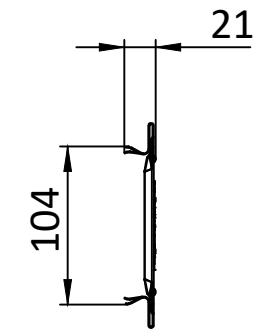
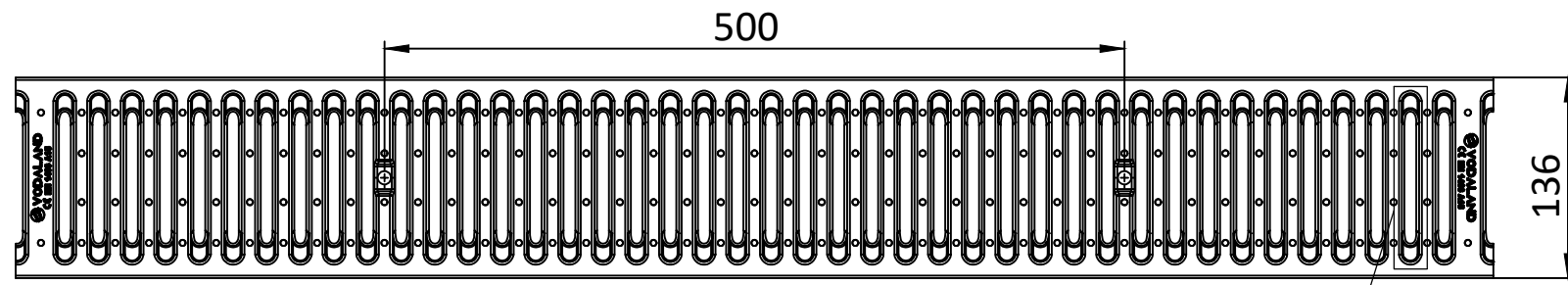

A (1 : 2)

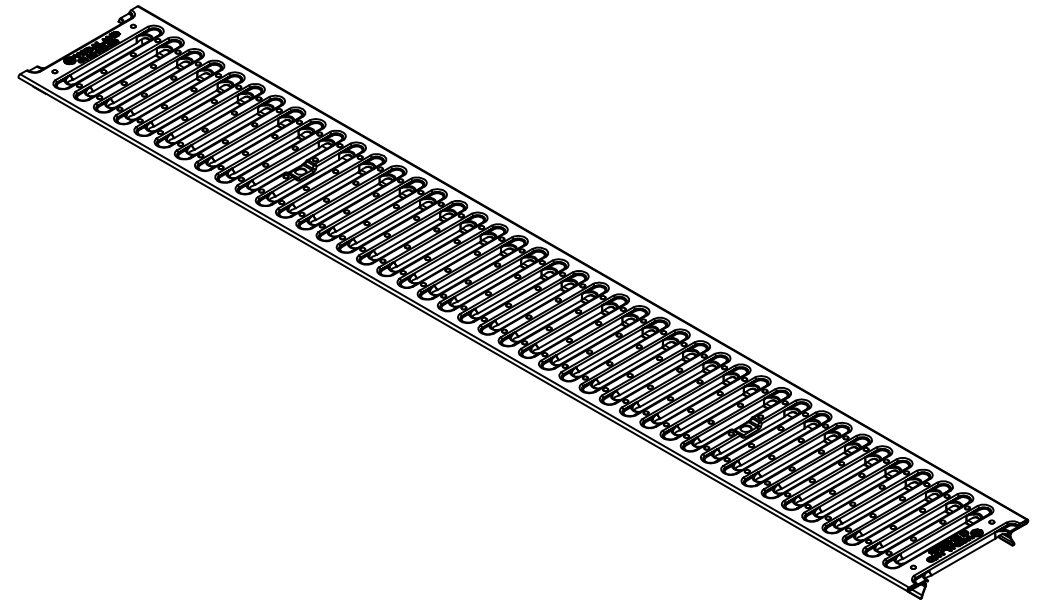
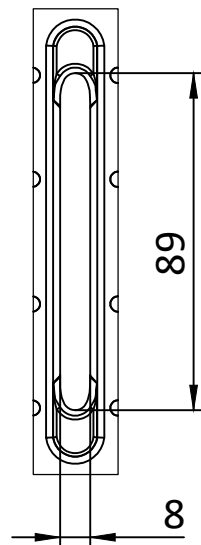

1. Abaterea greutății reale a nominalului poate fi de până la 12%
2. Suprafața fantelor de admisie a apei 297,13 mp

| DACA NU SE SPECIFICA ALTFEL, TOATE DIMENSIUNILE SUNT IN MM FINISARE SUPRAFATA: TOLERANTA: ISO 2768-b LINIAR: UNGHILAR: | | | | FINALIZAT: | | REVIZIA | | | | | | | | | | | | | | | | | | | | | | | | | | | |
|--|--|--|--|------------|--|-----------------------|----------|----------|--|--|--|---------|-----|----------|--|--|--|-----------|-----|--|--|--|--|---------|--|--|--|--|--|---|--|--------|--|
| <table border="1"> <thead> <tr> <th>NUME</th> <th>SEMNTURA</th> <th>DATA</th> <th></th> <th></th> <th></th> </tr> </thead> <tbody> <tr> <td>DESENAT</td> <td>LIL</td> <td>20.10.22</td> <td></td> <td></td> <td></td> </tr> <tr> <td>VERIFICAT</td> <td>LMK</td> <td></td> <td></td> <td></td> <td></td> </tr> <tr> <td>APROBAT</td> <td></td> <td></td> <td></td> <td></td> <td></td> </tr> </tbody> </table> | | | | | | NUME | SEMNTURA | DATA | | | | DESENAT | LIL | 20.10.22 | | | | VERIFICAT | LMK | | | | | APROBAT | | | | | |  | | TITLU: | |
| | | | | | | NUME | SEMNTURA | DATA | | | | | | | | | | | | | | | | | | | | | | | | | |
| | | | | | | DESENAT | LIL | 20.10.22 | | | | | | | | | | | | | | | | | | | | | | | | | |
| | | | | | | VERIFICAT | LMK | | | | | | | | | | | | | | | | | | | | | | | | | | |
| APROBAT | | | | | | | | | | | | | | | | | | | | | | | | | | | | | | | | | |
| Gratar OZ BASE fante | | | | | | | | | | | | | | | | | | | | | | | | | | | | | | | | | |
| | | | | | | Clasa de sarcina: A15 | | | | | | | | | | | | | | | | | | | | | | | | | | | |
| | | | | | | ARTICOL: | | | | | | | | | | | | | | | | | | | | | | | | | | | |
| | | | | | | 20101 | | | | | | | | | | | | | | | | | | | | | | | | | | | |
| | | | | | | A3 | | | | | | | | | | | | | | | | | | | | | | | | | | | |
| | | | | | | MATERIAL: | | | | | | | | | | | | | | | | | | | | | | | | | | | |
| | | | | | | Otel zincat | | | | | | | | | | | | | | | | | | | | | | | | | | | |
| | | | | | | GREUTATE: 1,19 kg | | | | | | | | | | | | | | | | | | | | | | | | | | | |
| | | | | | | SCARA:1:5 | | | | | | | | | | | | | | | | | | | | | | | | | | | |
| | | | | | | PAGINA 1 DIN 1 | | | | | | | | | | | | | | | | | | | | | | | | | | | |