

Rigola cu gratar D400

Rigola cu gratar D400 si iesire verticala 110

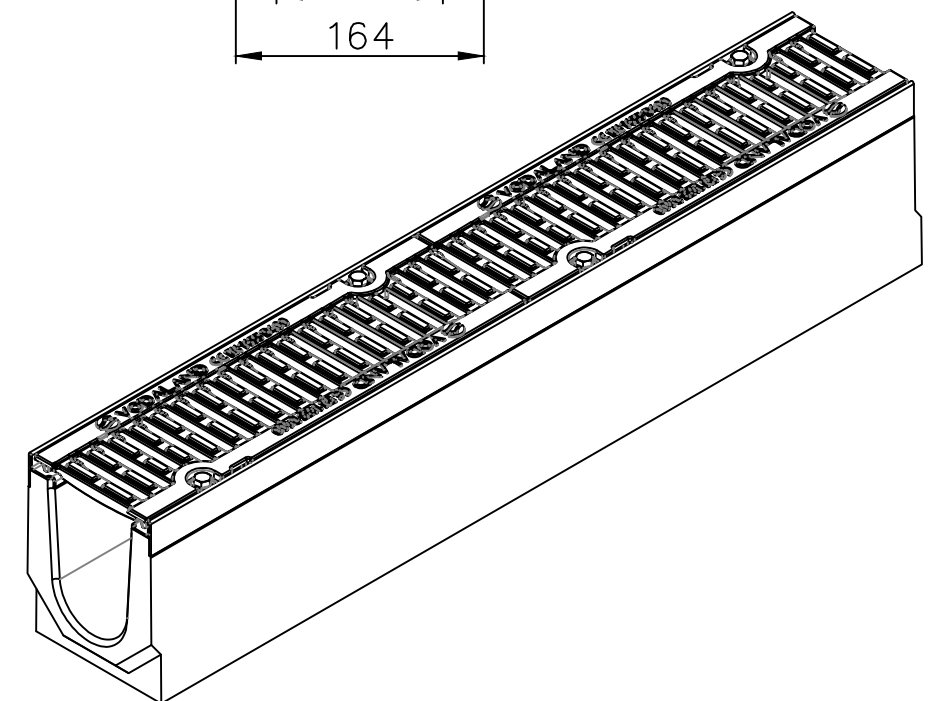

Article	H/h, mm	Weight kg	Article	H/h, mm	Weight, kg	Article	H/h, mm	Weight, kg	Article	H/h, mm	Weight, kg
040071334/230	230	53,6	040071334/230-225	230/225	52,8	04007133409/230	230	52,6	04007133409/230-225	230/225	51,8
040071334/225	225	52,9	040071334/225-220	225/220	52,1	04007133409/225	225	51,9	04007133409/225-220	225/220	51,1
040071334/220	220	52,3	040071334/220-215	220/215	51,4	04007133409/220	220	51,2	04007133409/220-215	220/215	50,4
040071334/215	215	51,6	040071334/215-210	215/210	50,8	04007133409/215	215	50,6	04007133409/215-210	215/210	49,8
040071334/210	210	50,9	040071334/210-205	210/205	50,1	04007133409/210	210	49,9	04007133409/210-205	210/205	49,1
040071334/205	205	50,2	040071334/205-200	205/200	49,4	04007133409/205	205	49,2	04007133409/205-200	205/200	48,4
040071334/200	200	49,5	040071334/200-195	200/195	48,7	04007133409/200	200	48,5	04007133409/200-195	200/195	47,7
040071334/195	195	48,9	040071334/195-190	195/190	48,0	04007133409/195	195	47,8	04007133409/195-190	195/190	47,0
040071334/190	190	48,2	040071334/190-185	190/185	47,4	04007133409/190	190	47,2	04007133409/190-185	190/185	46,4
040071334/185	185	47,5	040071334/185-180	185/180	46,7	04007133409/185	185	46,5	04007133409/185-180	185/180	45,7
040071334/180	180	46,8	040071334/180-175	180/175	46,0	04007133409/180	180	45,8	04007133409/180-175	180/175	45,0
040071334/175	175	46,1	040071334/175-170	175/170	45,3	04007133409/175	175	45,1	04007133409/175-170	175/170	44,3
040071334/170	170	45,5	040071334/170-165	170/165	44,6	04007133409/170	170	44,4	04007133409/170-165	170/165	43,6
040071334/165	165	44,8	040071334/165-160	165/160	44,0	04007133409/165	165	43,8	04007133409/165-160	165/160	43,0
040071334/160	160	44,1	040071334/160-155	160/155	43,3	04007133409/160	160	43,1	04007133409/160-155	160/155	42,3
040071334/155	155	43,4	040071334/155-150	155/150	42,6	04007133409/155	155	42,4	04007133409/155-150	155/150	41,6
040071334/150	150	42,7	040071334/150-145	150/145	41,9	04007133409/150	150	41,7	04007133409/150-145	150/145	40,9
040071334/145	145	42,1	040071334/145-140	145/140	41,2	04007133409/145	145	41,0	04007133409/145-140	145/140	40,2
040071334/140	140	41,4	040071334/140-135	140/135	40,6	04007133409/140	140	40,4	04007133409/140-135	140/135	39,6
040071334/135	135	40,7	040071334/135-130	135/130	39,9	04007133409/135	135	39,7	04007133409/135-130	135/130	38,9
040071334/130	130	40,0	040071334/130-125	130/125	39,2	04007133409/130	130	39,0	04007133409/130-125	130/125	38,2
040071334/125	125	39,3	040071334/125-120	125/120	38,5	04007133409/125	125	38,3	04007133409/125-120	125/120	37,5
040071334/120	120	38,6				04007133409/120	120	37,6			



1. Dimensiuni pentru referință
2. Livrarea și ambalarea se efectuează în conformitate cu termenii contractului de proiectare a produselor pentru îmbunătățirea parametrilor lor tehnologici și operaționali, ceea ce nu va afecta calitatea și proprietățile produsului.
3. Abateră greutății nominalului poate fi de până la 10%.

CU EXCEPȚIA CAZULUI ÎN CARE SE PREVEDE ALTFEL: DIMENSIUNILE SUNT ÎN MILIMETRI TOLERANȚE: ISO 2768 - C LINIAR: UNGHILUAR:			FINALIZAT:		REVIZIA
DESENAT: Kyselytsia			SEMNETURA:	DATA: 22.07.22	<p>TITLU: Kit rigola FB PRO LN100 Hext.120 muchii OZ gratar FONTA D400</p> <p>ARTICOL: 04007133409/120</p> <p>A3</p>
VERIFICAT: Kharambura					
APROBAT: Malynovskiy					
MODIFICAT: Larisa Chitu					
MATERIAL: Fibrobeton, Fonta					
GREUTATE: kg			SCARA:1:5	PAGINA 1 DIN 1	